

4/3, 4/2 and 3/2 directional valve with wet-pin DC or AC voltage solenoids

RE 23178/04.09
Replaces: 08.08

1/16

Type WE

Size 6
 Component series 6X
 Maximum operating pressure 350 bar [5076 psi]
 Maximum flow: 80 l/min [21 US gpm] – DC
 60 l/min [15.8 US gpm] – AC

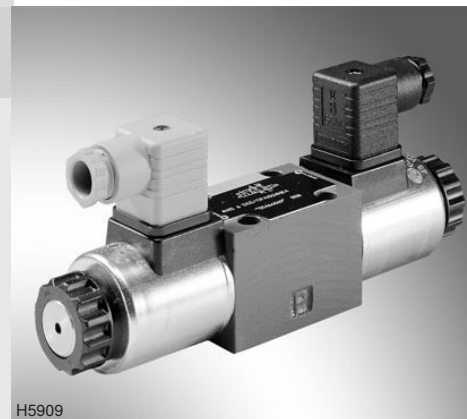

H5909

Table of contents

Contents	Page
Features	1
Ordering code	2, 3
Spool symbols	4
Function, section	5
Technical data	6, 7
Characteristic curves	8
Performance limits	8 to 10
Unit dimensions	11 to 15
Mating connector	16

Features

- Direct operated directional spool valve with solenoid actuation in high-performance design
- Porting pattern according to DIN 24340 form A
- Porting pattern according to ISO 4401-03-02-05 and NFPA T3.5.1 R2-2002 D03
- Subplates see data sheet RE 45052
- Wet-pin DC or AC voltage solenoids with detachable coil
- Solenoid coil can be rotated by 90°
- The coil can be changed without having to open the pressure-tight chamber
- Electrical connection as individual or central connection (for more electrical connections see RE 08010)
- Manual override, optional
- For smoothly switching variant, see RE 23183
- Inductive position switch and proximity sensor (contactless), see RE 24830
- Supplementary documentation:
 - "General product information on hydraulic products" RE 07008
 - "Installation, commissioning and maintenance of industrial valves" RE 07300

Information on available spare parts:
www.boschrexroth.com/spc

Ordering code

	WE	6	6X/	E				
3 main ports								
4 main ports								
Size 6								
Spool symbols e.g. C, E, EA, EB, etc; possible variants see page 4								
Component series 60 to 69 (60 to 69: unchanged installation and connection dimensions)								
With spring return								
Without spring return								
Without spring return with detent								
High-performance wet-pin solenoid with detachable coil								
DC voltage 24 V								
AC voltage 230 V 50/60 Hz								
AC voltage 120 V or 110 V 50/60 Hz								
DC voltage 205 V								
DC voltage solenoid with rectifier for AC voltage (not frequency-related; only available with plug-in connection with D cover, page 14) For further ordering codes for other voltages and frequencies, see page 7								
With concealed manual override (standard)								
With manual override								
Without manual override								

Electrical connection

Individual connection

Without mating connector with connector DIN EN 175301-803 = K4 ³⁾

Without mating connector with connector AMP Junior Timer = C4 ³⁾

Without mating connector with connector DT 04-2PA (Deutsch plug) = K40 ³⁾

Without mating connector with M12x1 plug-in connection with operating display LED = K72L ⁴⁾

Without mating connector with M12x1 plug-in connection with operating display LED
(no connection pin 1 to pin 2) = K73L ⁴⁾

Central connection

Cable entry at the cover, with indicator light = DL

Central plug-in connection at the cover, with indicator light (without mating connector) = DKL ⁵⁾

For further electrical connections, see RE 08010

¹⁾ For the connection to AC voltage mains, a DC voltage solenoid **must** be used, which is controlled via a rectifier (see table below).

In the case of individual connection, a large mating connector with integrated rectifier can be used (separate order).

²⁾ Locating pin ISO 8752-3x8-St, material no. **R900005694** (separate order)

³⁾ Mating connectors, separate order, see page 16 and RE 08006.

⁴⁾ Only version "G24", see RE 08010

⁵⁾ Mating connectors, separate order, material no. **R900005538**

AC voltage mains (permissible voltage tolerance ± 10%)	Nominal voltage of the DC solenoid when operated with AC voltage	Ordering code
110 V - 50/60 Hz	96 V	G96
230 V - 50/60 Hz	205 V	G205

Standard types and components are contained in the EPS (standard price list).



Further details in the plain text

No code =
/60 ²⁾ =
/62 =

Without locating hole
With locating hole
With locating hole and locating pin
ISO 8752-3x8-St

No code =
V =

Seal material
NBR seals
FKM seals
(other seals upon request)
Attention!
Observe compatibility of seals with the hydraulic fluids used!

No code =
Z =

Clamping length
42 mm [1.65 inch] (Standard)
22 mm [0.87 inch]

No code =

Without throttle insert
With throttle insert see table:

Connection	Throttle Ø in mm [inch]		
	0.8 [0.031]	1.0 [0.039]	1.2 [0.047]
P	= B08	= B10	= B12
A	= H08	= H10	= H12
B	= R08	= R10	= R12
A and B	= N08	= N10	= N12
T	= X08	= X10	= X12

Use at flows which exceed the performance limit of the valve (see page 5).

No code =

Spool position monitoring
Without position switch

QMAG24 =

– **Inductive position switch type QM**

QMBG24 =

Monitored spool position "a"

QM0G24 =

Monitored spool position "b"

Monitored rest position

QR0G24S =

– **Inductive position switch type QR**

QRABG24E =

Monitored rest position

Monitored spool position "a" and "b"

QSAG24W =

– **Inductive proximity sensor type QS**

QSBG24W =

Monitored spool position "a"

QS0G24W =

Monitored spool position "b"

QS0AG24W =

Monitored spool position "0"

QS0BG24W =

Monitored spool position "0" and "a"

QSABG24W =

Monitored spool position "0" and "b"

Monitored spool position "a" and "b"

For further details, see RE 24830

Spool symbols

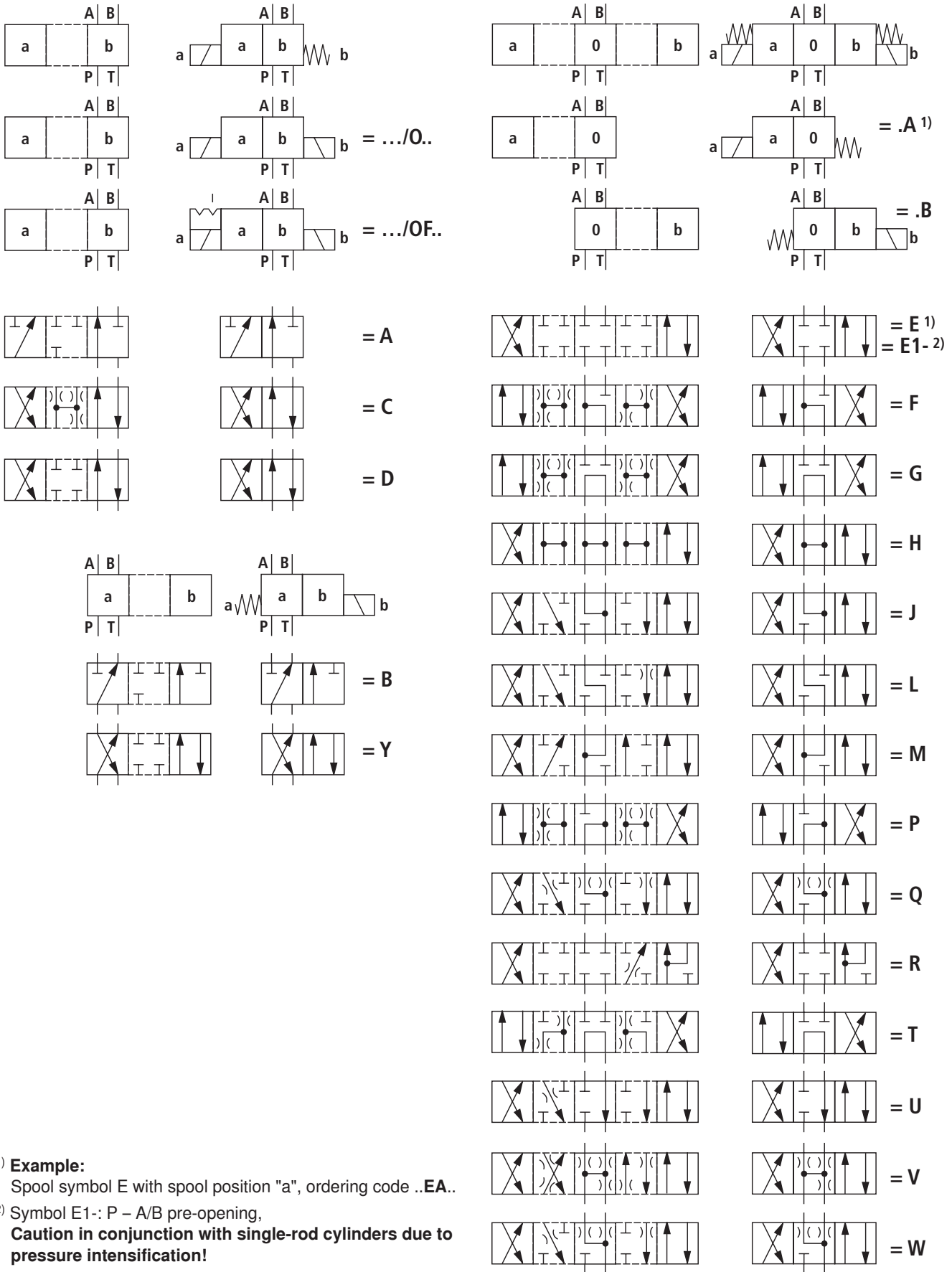

¹ **Example:**
Spool symbol E with spool position "a", ordering code ..EA..

² Symbol E1-: P – A/B pre-opening,
Caution in conjunction with single-rod cylinders due to pressure intensification!

Function, section

Directional valves of type WE are solenoid operated directional spool valves. They control the start, stop and direction of a flow.

The directional valves basically consist of housing (1), one or two solenoids (2), control spool (3), and one or two return springs (4).

In the de-energized condition, control spool (3) is held in the central position or in the initial position by the return springs (4) (except for impulse spool). Control spool (3) is actuated by wet-pin solenoids (2).

To ensure proper functioning, care must be taken that the pressure chamber of the solenoid is filled with oil.

The force of solenoid (2) acts via plunger (5) on control spool (3) and pushes the latter from its rest position to the required end position. This enables the necessary direction of flow from P to A and B to T or P to B and A to T.

After solenoid (2) was de-energized, return spring (4) pushes control spool (3) again back to its rest position.

An optional manual override (6) allows control spool (3) to be moved without energization of the solenoid.

Type .WE 6 .6X/O... (only possible with symbols A, C and D)

This variant is a directional valve with two spool positions and two solenoids without detent. In the de-energized condition, there is no defined spool position.

Type .WE 6 .6X/OF... (impulse spool, only possible with symbols A, C and D)

This variant is a directional valve with two spool positions, two solenoids and one detent. It alternately locks the two spools in position and the solenoid therefore needs not to be permanently energized.

Notes!

Pressure peaks in the tank line to two or several valves can result in unwanted spool movements in the case of valves with detent! We therefore recommend that separate return lines be provided or a check valve installed in the tank line.

Internal leakage of a directional spool valve changes in the course of time for component-inherent reasons.

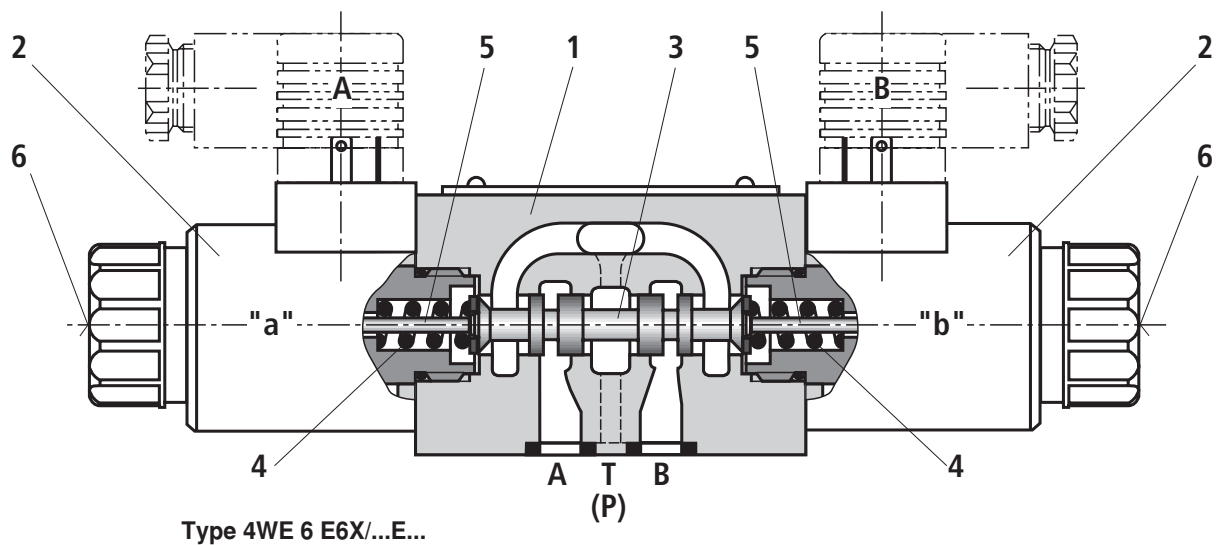

Throttle insert

The use of a throttle insert is required when, due to prevailing operating conditions, flows can occur during the switching processes, which exceed the performance limit of the valve.

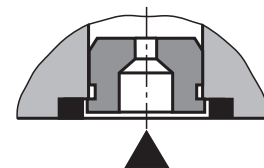

Technical data (For applications outside these parameters, please consult us!)

general			
Weight	– Valve with one solenoid	kg [lbs]	1.45 [3.2]
	– Valve with two solenoids	kg [lbs]	1.95 [4.3]
Installation position			any
Ambient temperature range		°C [°F]	–30 to +50 [–22 to +122] (NBR seals) –20 to +50 [–4 to +122] (FKM seals)
hydraulic			
Maximum operating pressure	– Port A, B, P	bar [psi]	350 [5076]
	– Port T	bar [psi]	210 [3050] (DC); 160 [2320] (AC) With symbols A and B, port T must be used as leakage port.
Maximum flow		l/min [US gpm]	80 [21] (DC); 60 [15.8] (AC)
Flow cross-section (Spool position 0)	– Spool symbol Q	mm ²	ca. 6 % of nominal cross-section
	– Spool symbol W	mm ²	ca. 3 % of nominal cross-section
Hydraulic fluid ¹⁾			Mineral oil (HL, HLP) according to DIN 51524 ²⁾ ; quickly bio-degradable hydraulic fluids according to VDMA 24568 (see also RE 90221); HETG (rape seed oil) ²⁾ ; HEPG (polyglycols) ³⁾ ; HEES (synthetic esters) ³⁾ ; other hydraulic fluids upon request
Hydraulic fluid temperature range		°C [°F]	–30 to +80 [–22 to +176] (NBR seals) –15 to +80 [–4 to +176] (FKM seals)
Viscosity range		mm ² /s [SUS]	2.8 to 500 [35 to 2320]
Maximum permitted degree of contamination of the hydraulic fluid - cleanliness class according to ISO 4406 (c)			Class 20/18/15 ⁴⁾

¹⁾ The flashpoint of the process and operating medium used must be 15 K higher than the maximum solenoid surface temperature.

²⁾ Suitable for NBR and FKM seals

³⁾ Only suitable for FKM seals

⁴⁾ The cleanliness classes specified for the components must be adhered to in hydraulic systems. Efficient filtration prevents malfunctions and at the same time prolongs the service life of components.

For maintenance requirements of the hydraulic fluid and contamination limit values, see data sheet RE 07300.

For the selection of the filters, see data sheets RE 50070, RE 50076, RE 50081, RE 50086, RE 50087 and RE 50088.

Technical data (For applications outside these parameters, please consult us!)

electrical

Type of voltage		Direct voltage	Alternating voltage 50/60 Hz
Available voltages ⁵⁾ (For ordering code for AC voltage solenoids, see below)	V	12, 24, 96, 205	110, 230
Voltage tolerance (nominal voltage)	%	±10	
Power consumption	W	30	–
Holding power	VA	–	50
Switch-on power	VA	–	220
Duty cycle (ED)	%	100	
Switching time – ON	ms	25 to 45	10 to 20
according to – OFF ISO 6403 ⁶⁾	ms	10 to 25	15 to 40
Maximum switching frequency	1/h	15000	7200
Maximum surface temperature of the coil ⁷⁾	°C [°F]	120 [248]	180 [356]
Type of protection according to DIN EN 60529	– with connector "K4", "K72L", "K73L" – with connector "C4" – with connector "K40"	IP 65 (with mating connector mounted and locked) IP 66A (with mating connector mounted and locked) IP 69K (with mating connector mounted and locked)	

⁵⁾ Special voltages upon request

⁶⁾ The switching times were established at a hydraulic fluid temperature of 40 °C [104 °F] and a viscosity of 46 cSt. Deviating hydraulic fluid temperatures can result in different switching times! Switching times change in dependence on the operating time and operating conditions.

⁷⁾ Due to the temperatures occurring on the surfaces of the solenoid coils, the standards ISO 13732-1 and EN 982 need to be adhered to!
The specified surface temperature in AC voltage solenoids is valid for the faultless operation. In case of faults (e.g. blocking of the control spool), the surface temperature may rise to above 180 °C [356 °F]. Thus, the system must be checked for possible hazards considering the flashpoint (see footnote ¹⁾ page 6).
As fuse protection, circuit breakers (see table page 16) must be used unless the creation of an ignitable atmosphere can be excluded in a different way. Thus, the surface temperature can - in case of fault - be limited to maximally 220 °C [428 °F].
The tripping current must be 8 to 10 times higher than the nominal power consumption over a time span of 0.6 s. (tripping characteristics "K").
The necessary non-tripping current of the fuse must not fall below the value I_1 (see table page 16). The maximum tripping current of the fuse must not exceed the value I_2 (see table page 16).
The temperature dependence of the tripping behavior of the circuit breakers has to be considered according to the manufacturer's specifications.

Notes!

- Operation of the manual override is only possible up to a tank pressure of ca. 50 bar [725 psi]. Avoid damage to the bore for the manual override! (Special tool for actuation, separate order, material no. **R900024943**). When the manual override is blocked, the operation of the solenoid must be ruled out!
- The simultaneous operation of the solenoids must be ruled out!

When establishing the electrical connection, properly connect the protective earth conductor (PE \perp).

Note!

AC voltage solenoids can be used for 2 or 3 mains;
e. g. solenoid type **W110** for:
110 V, 50 Hz; 110 V, 60 Hz; 120 V, 60 Hz

Ordering code	Mains
W110	110 V, 50 Hz
	110 V, 60 Hz
	120 V, 60 Hz
W230	230 V, 50 Hz
	230 V, 60 Hz

Characteristic curves (measured with HLP46, $\vartheta_{Oil} = 40 \text{ }^\circ\text{C} \pm 5 \text{ }^\circ\text{C} [104 \text{ }^\circ\text{F} \pm 9 \text{ }^\circ\text{F}]$)

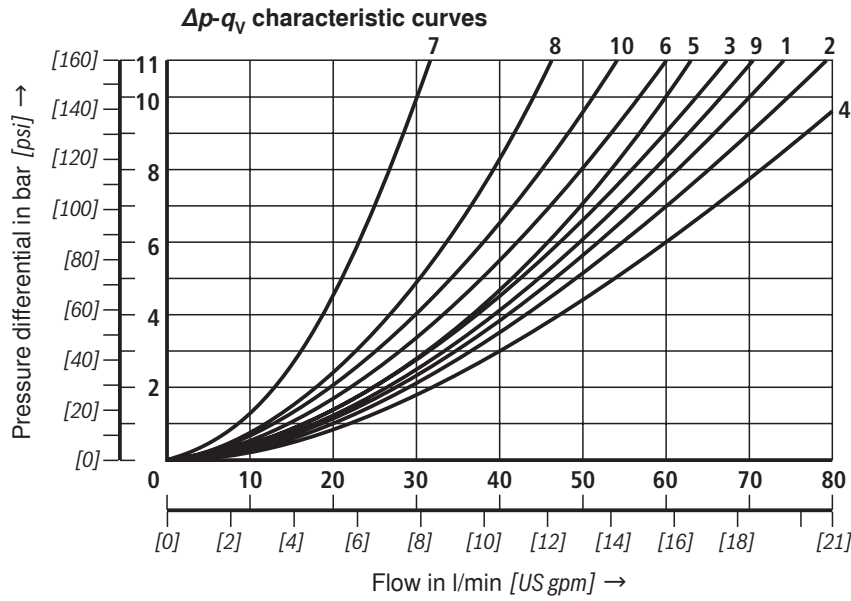

Spool symbol	Flow direction			
	P – A	P – B	A – T	B – T
A; B	3	3	–	–
C	1	1	3	1
D; Y	5	5	3	3
E	3	3	1	1
F	1	3	1	1
T	10	10	9	9
H	2	4	2	2
J; Q	1	1	2	1
L	3	3	4	9
M	2	4	3	3
P	3	1	1	1
R	5	5	4	–
V	1	2	1	1
W	1	1	2	2
U	3	3	9	4
G	6	6	9	9

- 7 Spool symbol "R" in spool position B – A
- 8 Spool symbol "G" and "T" in central position P – T
- 9 Spool symbol "H" in central position P – T

Performance limits (measured with HLP46, $\vartheta_{Oil} = 40 \text{ }^\circ\text{C} \pm 5 \text{ }^\circ\text{C} [104 \text{ }^\circ\text{F} \pm 9 \text{ }^\circ\text{F}]$)

Attention!

The specified switching performance limits are valid for operation with two directions of flow (e.g. from P to A and simultaneous return flow from B to T).

Due to the flow forces acting within the valves, the permissible switching performance limits may be considerably lower

with only one direction of flow (e.g. from P to A while port B is blocked)!

In such cases, please consult us!

The switching performance limit was established while the solenoids were at operating temperature, at 10% undervoltage and without tank pre-loading.

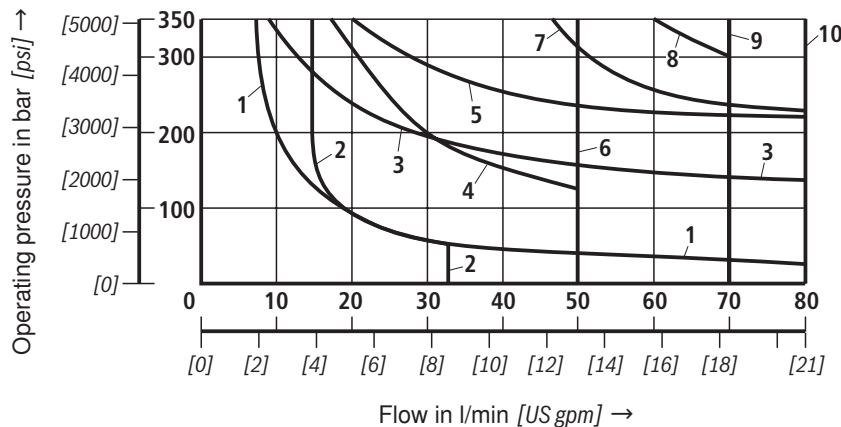

DC solenoid Solenoid voltage
12; 24; 48; 96; 125; 205 V

(other voltages see page 10)

Characteristic curve	DC solenoid Spool symbol
	1
2	V
3	A; B
4	F; P
5	J
6	G; H; T
7	A/O; A/OF; L; U
8	C; D; Y
9	M
10	E; E1 ⁻²⁾ ; R ³⁾ ; C/O; C/OF; D/O; D/OF; Q; W

¹⁾ With manual override

²⁾ P – A/B pre-opening

³⁾ Return flow from actuator to tank

Performance limits (measured with HLP46, $\vartheta_{Oil} = 40\text{ °C} \pm 5\text{ °C}$ [$104\text{ °F} \pm 9\text{ °F}$])

see note on page 8.

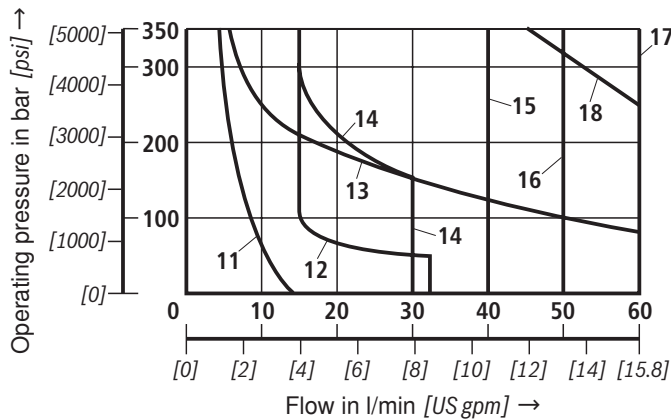

AC solenoid Solenoid voltage	
W110	110 V; 50 Hz 120 V; 60 Hz
W230	230 V; 50 Hz

(other voltages upon request)

AC solenoid – 50 Hz	
Character-istic curve	Spool symbol
11	A; B ¹⁾
12	V
13	A; B
14	F; P
15	G; T
16	H
17	A/O; A/OF; C/O; C/OF; D/O; D/OF; E; E1- ²⁾ ; J; L; M; Q; R ³⁾ ; U; W
18	C; D; Y

¹⁾ With manual override

²⁾ P – A/B pre-opening

³⁾ Return flow from actuator to tank

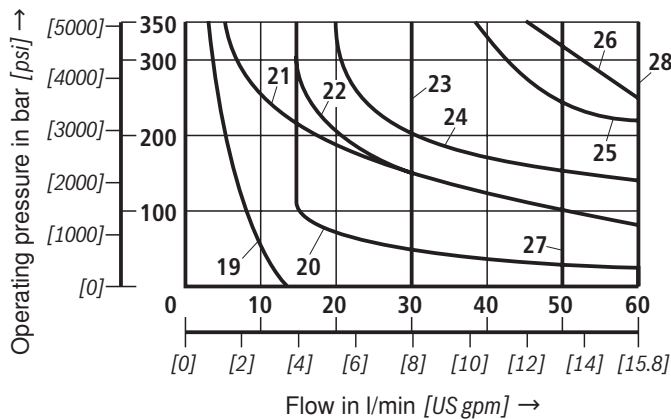

AC solenoid Solenoid voltage	
W110	110 V; 60 Hz
W230	230 V; 60 Hz

(other voltages upon request)

AC solenoid – 60 Hz	
Character-istic curve	Spool symbol
19	A; B ¹⁾
20	V
21	A; B
22	F; P
23	G; T
24	J; L; U
25	A/O; A/OF; Q; W
26	C; D; Y
27	H
28	C/O; C/OF; D/O; D/OF; E E1- ²⁾ ; M; R ³⁾

¹⁾ With manual override

²⁾ P – A/B pre-opening

³⁾ Return flow from actuator to tank

Performance limits (measured with HLP46, $\vartheta_{Oil} = 40 \text{ }^\circ\text{C} \pm 5 \text{ }^\circ\text{C} [104 \text{ }^\circ\text{F} \pm 9 \text{ }^\circ\text{F}]$)

see note on page 8.

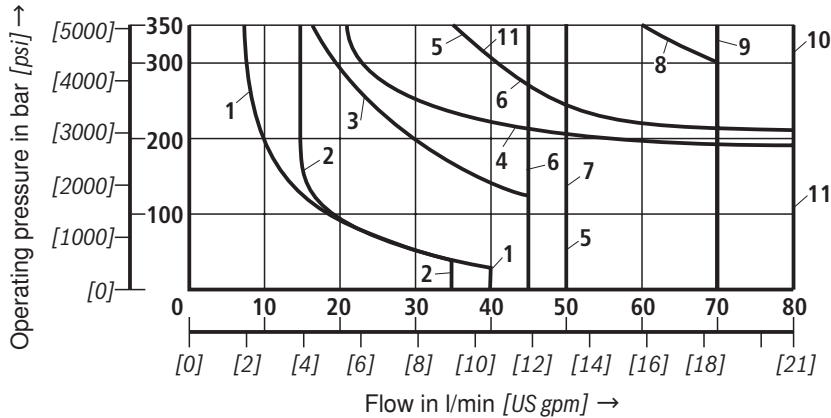

DC solenoid
Solenoid voltage
110; 180 V

DC solenoid	
Character-istic curve	Spool symbol
1	A; B
2	V
3	F; P
4	J; L; U
5	G
6	T
7	H
8	D; C
9	M
10	C/O; C/OF; D/O; D/OF; E; E1-; R, Q; W
11	A/O; A/OF

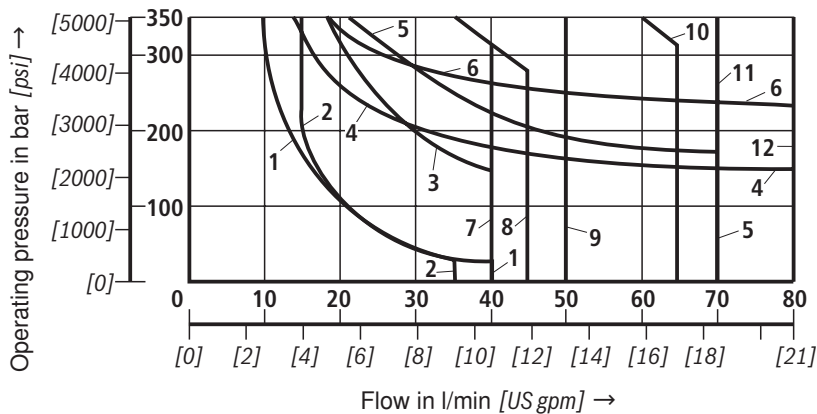

DC solenoid
Solenoid voltage
42; 80; 220 V

DC solenoid	
Character-istic curve	Spool symbol
1	A; B
2	V
3	F; P
4	J; L; U
5	A/O; A/OF
6	E
7	T
8	G
9	H
10	D; C
11	M
12	C/O; C/OF; D/O; D/OF; E1-; R, Q; W

Unit dimensions: Valve with DC solenoid – Individual connection
(dimensions in mm [inch])

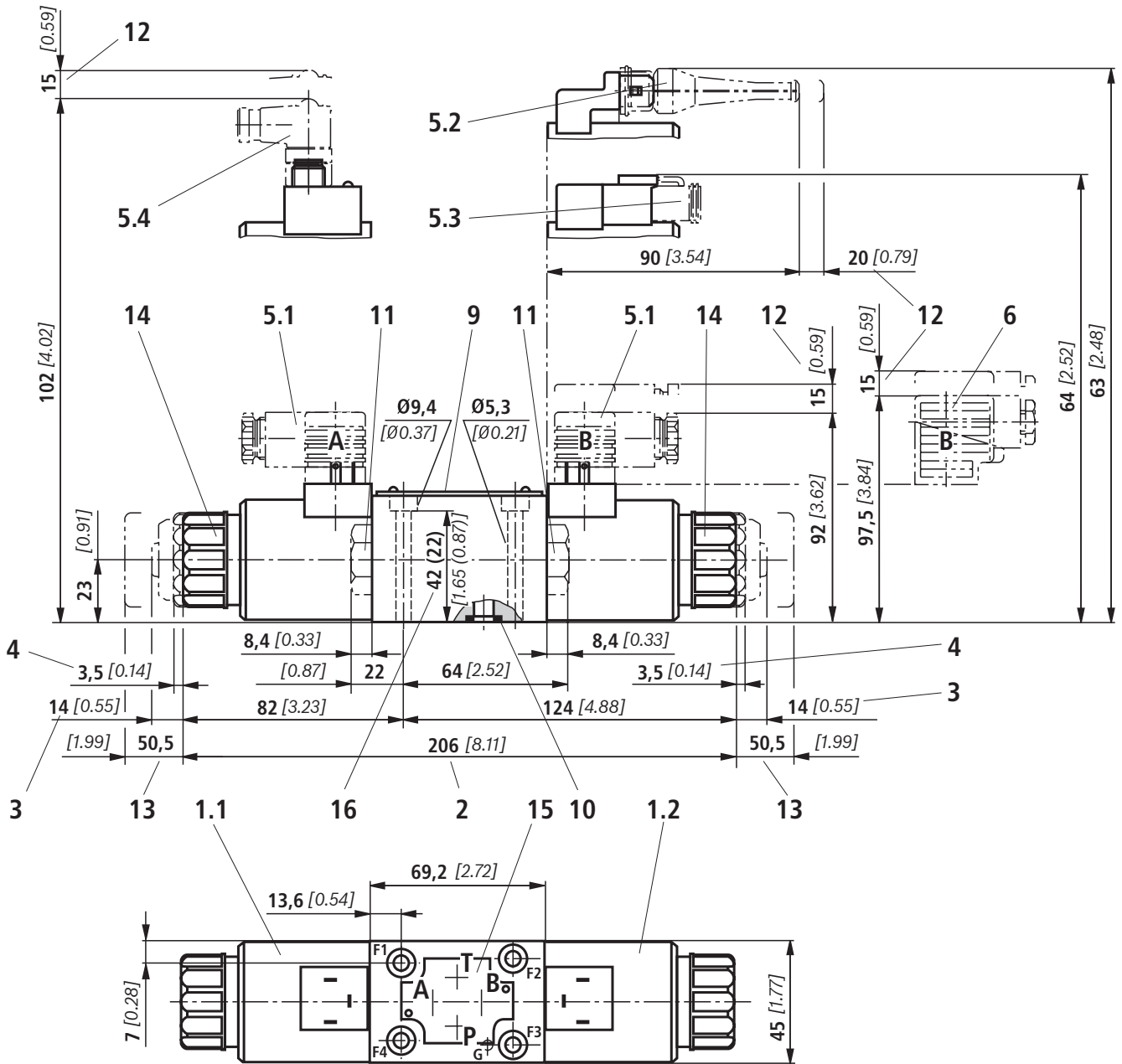

Item explanations, valve mounting screws and subplates see page 15.

0,01/100
[0.0004/4.0]
Rzmax 4

Required surface quality of the valve mounting face

Unit dimensions: Valve with DC solenoid – Central connection
(dimensions in mm [inch])

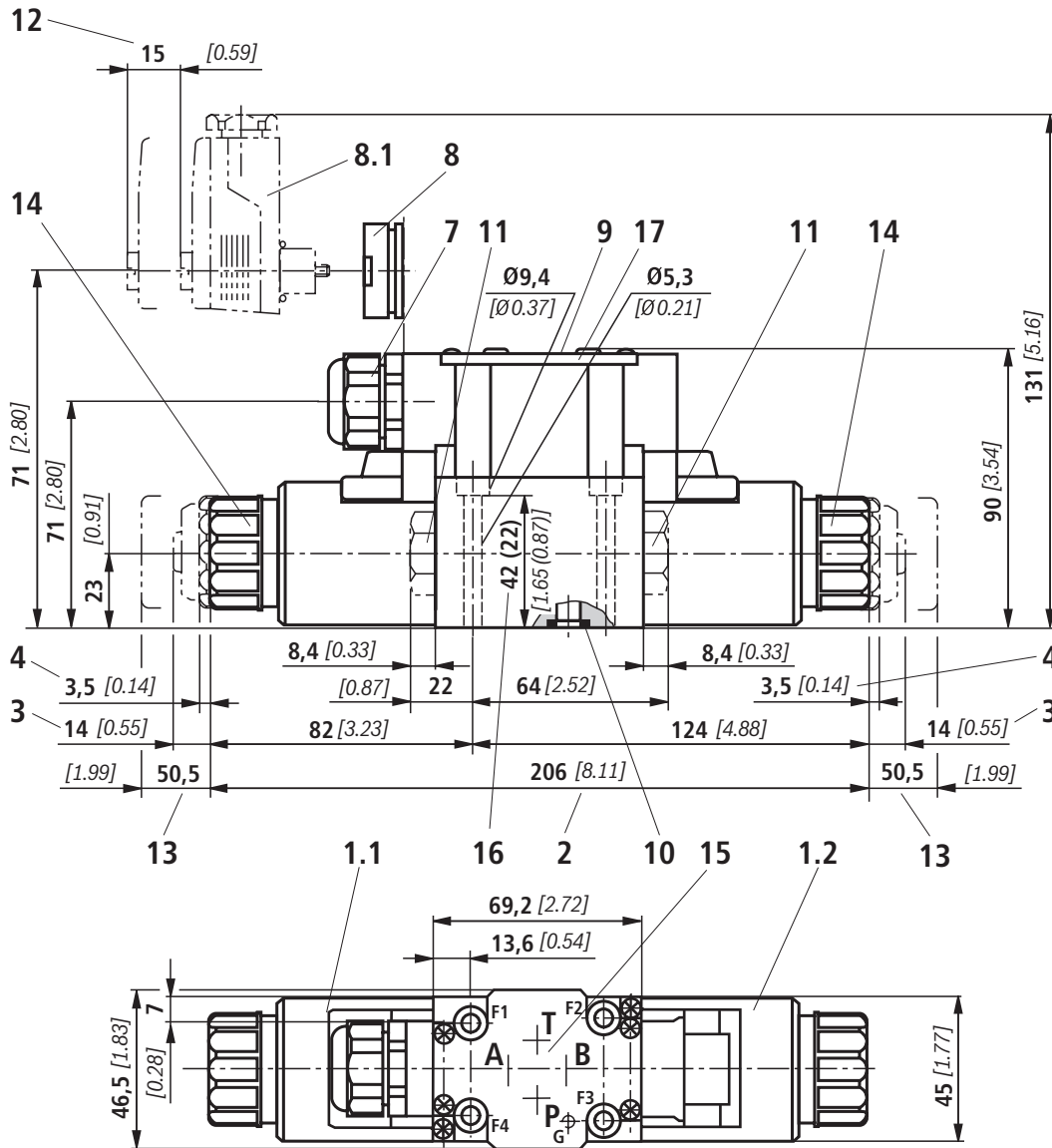

Required surface quality
 of the valve mounting face

Terminal assignment with central connection:

- **1 solenoid:**
Solenoid always to terminals 1 and 2,
protective earth conductor to terminal ⊕ PE
- **2 solenoids:**
Solenoid "a" to terminals 1 and 2,
solenoid "b" to terminals 3 and 4,
protective earth conductor to terminal ⊕ PE

Item explanations, valve mounting screws and subplates
see page 15.

Unit dimensions: Valve with AC solenoid – Individual connection
(dimensions in mm [inch])

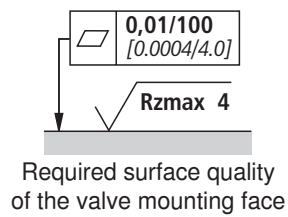
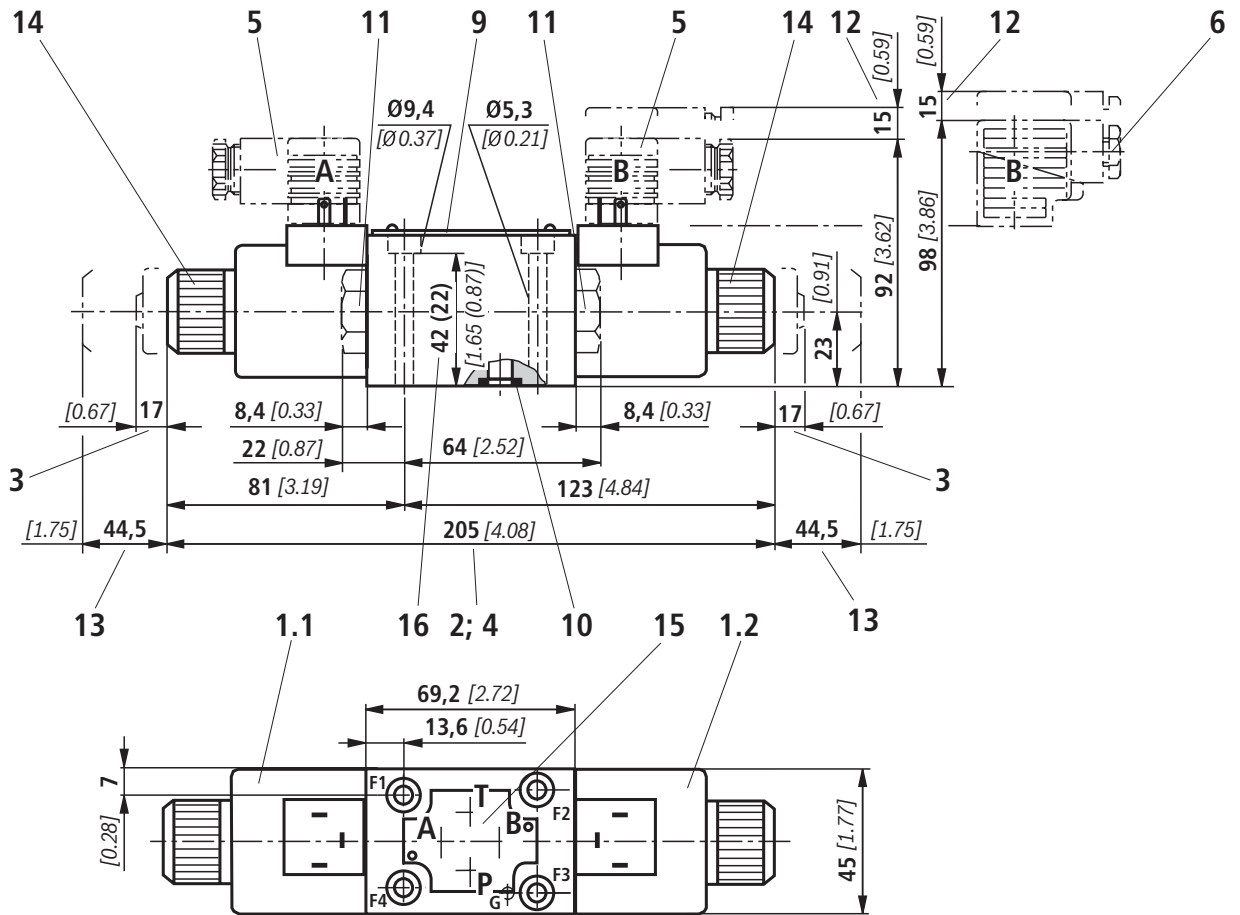

Item explanations, valve mounting screws and subplates
see page 15.

Unit dimensions: Valve with AC solenoid – Central connection
(dimensions in mm [inch])

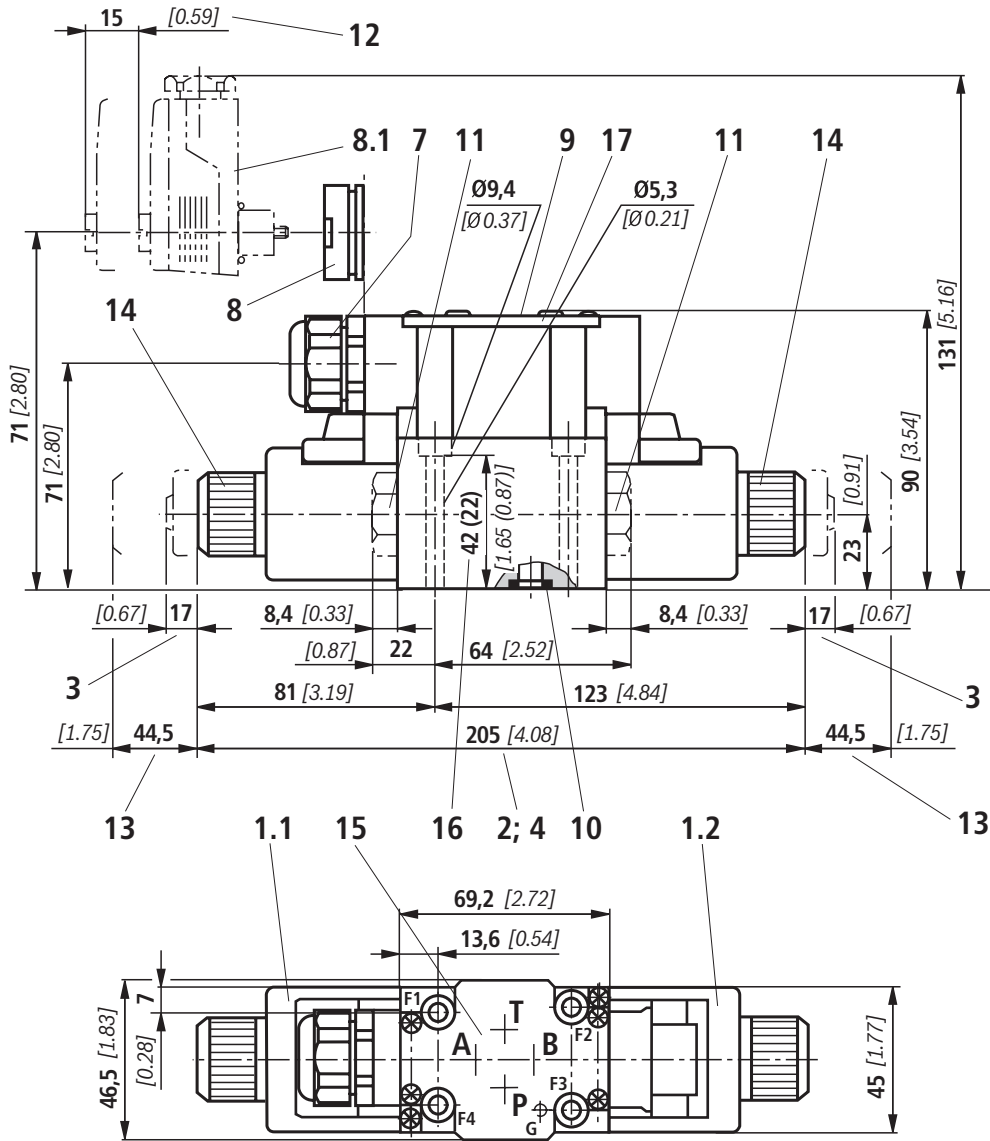

Required surface quality
 of the valve mounting face

Terminal assignment with central connection:

- **1 solenoid:**
Solenoid always to terminals 1 and 2,
protective earth conductor to terminal ⊕ PE
- **2 solenoids:**
Solenoid "a" to terminals 1 and 2,
solenoid "b" to terminals 3 and 4,
protective earth conductor to terminal ⊕ PE

Item explanations, valve mounting screws and subplates
see page 15.

Unit dimensions

- 1.1 Solenoid "a"
- 1.2 Solenoid "b"
 - 2 Dimension for solenoid **with concealed** manual override "N9" (standard)
 - 3 Dimension for solenoid **with** manual override "N9"
 - 4 Dimension for solenoid **without** manual override
- 5.1 Mating connector **without** circuitry for connector "K4" (separate order, see page 16 and RE 08006)
- 5.2 Mating connector (AMP Junior Timer) with connector "C4" (separate order, see RE 08006)
- 5.3 Mating connector DT 04-2PA (Deutsch plug) with connector "K40" (separate order, see RE 08006)
- 5.4 Mating connector angled with M12x1 plug-in connection with operating display LED "K33L" (separate order, see RE 08006)
 - 6 Mating connector **with** circuitry for connector "K4" (separate order, see page 16 and RE 08006)
 - 7 Cable gland Pg 16 [1/2" NPT] "DL"
 - 8 Central plug-in connection "DKL"
- 8.1 Angled socket (color red, separate order) material no. **R900005538**
- 9 Nameplate
- 10 Identical seal rings for ports A, B, P, T

 **Note!** The ports are clearly determined according to their tasks and must not be arbitrarily interchanged or closed.
- 11 Plug screw for valves with one solenoid
- 12 Space required for removing the mating connector/angled socket
- 13 Space required for removing the coil
- 14 Lock nut, tightening torque $M_A = 4^{+1}$ Nm [2.95^{+0.74} ft-lbs]
- 15 Position of the connections according to DIN 24340 form A (**without** locating hole), or ISO 4401-03-02-0-05 and NFPA T3.5.1 R2-2002 D03 (**with** locating hole for locating pin ISO 8752-3x8-St, material no. **R900005694**, separate order)
- 16 Alternative clamping length (): 22 mm [0.87 inch]
- 17 Cover

Attention!

The valve may only be operated with properly mounted cover!

Subplates according to data sheet RE 45052 (separate order)

(without locating hole)	G 341/01 (G1/4) G 342/01 (G3/8) G 502/01 (G1/2)
(with locating hole)	G 341/60 (G1/4) G 342/60 (G3/8) G 502/60 (G1/2) G 341/12 (SAE-6) ¹⁾ G 342/12 (SAE-8) ¹⁾ G 502/12 (SAE-10) ¹⁾

¹⁾ on request

Valve mounting screws (separate order)

– Clamping length 42 mm:

4 hexagon socket head cap screws, metric ISO 4762 - M5 x 50 - 10.9-f1Zn-240h-L

(friction coefficient $\mu_{\text{total}} = 0.09$ to 0.14);
tightening torque $M_A = 7$ Nm [5.2 ft-lbs] $\pm 10\%$,
material no. **R913000064**

or

4 hexagon socket head cap screws

ISO 4762 - M5 x 50 - 10.9 (own procurement)

(friction coefficient $\mu_{\text{total}} = 0.12$ to 0.17);
tightening torque $M_A = 8.1$ Nm [6 ft-lbs] $\pm 10\%$

4 hexagon socket head cap screws UNC 10-24 UNC x 2" ASTM-A574

(friction coefficient $\mu_{\text{total}} = 0.19$ to 0.24);
tightening torque $M_A = 11$ Nm [8.2 ft-lbs] $\pm 15\%$,
(friction coefficient $\mu_{\text{total}} = 0.12$ to 0.17);
tightening torque $M_A = 8$ Nm [5.9 ft-lbs] $\pm 10\%$,
material no. **R978800693**

– Clamping length 22 mm:

4 hexagon socket head cap screws, metric ISO 4762 - M5 x 30 - 10.9-f1Zn-240h-L

(friction coefficient $\mu_{\text{total}} = 0.09$ to 0.14);
tightening torque $M_A = 7$ Nm [5.2 ft-lbs] $\pm 10\%$,
material no. **R913000316**

or

4 hexagon socket head cap screws

ISO 4762 - M5 x 30 - 10.9 (own procurement)

(friction coefficient $\mu_{\text{total}} = 0.12$ to 0.17);
tightening torque $M_A = 8.1$ Nm [6 ft-lbs] $\pm 10\%$

4 hexagon socket head cap screws UNC 10-24 UNC x 1 1/4"

(friction coefficient $\mu_{\text{total}} = 0.19$ to 0.24);
tightening torque $M_A = 11$ Nm [8.2 ft-lbs] $\pm 15\%$,
(friction coefficient $\mu_{\text{total}} = 0.12$ to 0.17);
tightening torque $M_A = 8$ Nm [5.9 ft-lbs] $\pm 10\%$,
material no. **R978802879**

Mating connectors according to DIN EN 175301-803

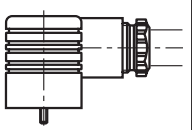
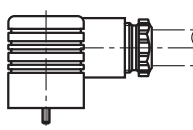
Details and more mating connectors see RE 08006			 				
Connection	Valve side	Color	Material number				
			without circuitry	with indicator light 12 ... 240 V	with indicator light and rectifier 12 ... 240 V	with rectifier 12 ... 240 V	with indicator light and Zener diode suppression circuit 24 V
M16 x 1.5	a	gray	R901017010	–	–	–	–
	b	black	R901017011	–	–	–	–
	a/b	black	–	R901017022	R901017029	R901017025	R901017026
1/2" NPT (Pg 16)	a	red/ brown	R900004823	–	–	–	–
	b	black	R900011039	–	–	–	–
	a/b	black	–	R900057453	R900057455	R900842566	–

Circuit breakers with tripping characteristic "K"

according to EN 60898-1 (VDE 0641-11), EN 60947-2 (VDE 0660-101), IEC 60898 and IEC 60947-2

AC solenoid, 50 Hz	Lower rated current I_1 in A	Upper rated current I_2 in A
W24	2.30	3.60
W42	1.45	1.92
W48	1.15	1.92
W100	0.64	0.90
W110	0.60	0.90
W115	0.52	0.90
W127	0.48	0.60
W200	0.33	0.60
W220	0.31	0.60
W230	0.26	0.36
W240	0.26	0.36

AC solenoid, 60 Hz	Lower rated current I_1 in A	Upper rated current I_2 in A
W24	1.73	2.40
W42	1.13	1.92
W48	1.09	1.92
W100	0.58	0.90
W110	0.52	0.90
W115	0.43	0.90
W127	0.37	0.60
W200	0.30	0.60
W220	0.26	0.36
W230	0.20	0.36
W240	0.22	0.36

Bosch Rexroth AG
Hydraulics
Zum Eisengießer 1
97816 Lohr am Main, Germany
Phone +49 (0) 93 52 / 18-0
Fax +49 (0) 93 52 / 18-23 58
documentation@boschrexroth.de
www.boschrexroth.de

© This document, as well as the data, specifications and other information set forth in it, are the exclusive property of Bosch Rexroth AG. It may not be reproduced or given to third parties without its consent. The data specified above only serve to describe the product. No statements concerning a certain condition or suitability for a certain application can be derived from our information. The information given does not release the user from the obligation of own judgment and verification. It must be remembered that our products are subject to a natural process of wear and aging.